



Features

- Low On-Resistance
- Fast Switching Speed
- 100% avalanche tested
- Lead Free and Green Devices Available (RoHS Compliant)

Application

- DC/DC Converters
- On board power for server
- Synchronous rectification

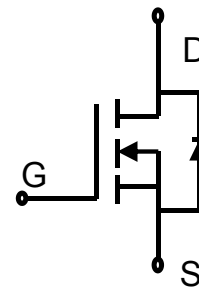

N-channel

Product Summary

| | | |
|-----------------------------|-----|------------|
| V_{DSS} | 40 | V |
| $R_{DS(ON)-Typ@V_{GS}=10V}$ | 4.8 | m Ω |
| I_D | 80 | A |

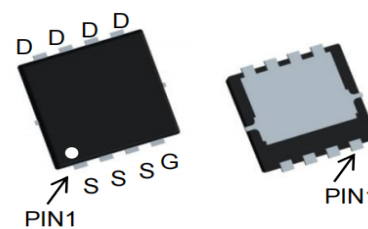

PDFN5060

Absolute Maximum Ratings

| Symbol | Parameter | Rating | Unit |
|--|---|-------------------------------|------------------|
| Common Ratings ($T_C=25^\circ\text{C}$ Unless Otherwise Noted) | | | |
| V_{DSS} | Drain-Source Voltage | 40 | V |
| V_{GSS} | Gate-Source Voltage | ± 20 | |
| T_J | Maximum Junction Temperature | 150 | $^\circ\text{C}$ |
| T_{STG} | Storage Temperature Range | -55 to 150 | $^\circ\text{C}$ |
| I_S | Diode Continuous Forward Current | $T_C=25^\circ\text{C}$ 80 | A |
| Mounted on Large Heat Sink | | | |
| $I_{DP}^{(1)}$ | 300 μs Pulse Drain Current Tested | $T_C=25^\circ\text{C}$ 320 | A |
| $I_D^{(2)}$ | Continuous Drain Current@ $T_C(V_{GS}=10V)$ | $T_C=25^\circ\text{C}$ 80 | A |
| | | $T_C=100^\circ\text{C}$ 51 | |
| | Continuous Drain Current@ $T_A(V_{GS}=10V)^{(3)}$ | $T_A=25^\circ\text{C}$ 25 | |
| | | $T_A=70^\circ\text{C}$ 19 | |
| P_D | Maximum Power Dissipation@ T_C | $T_C=25^\circ\text{C}$ 58 | W |
| | | $T_C=100^\circ\text{C}$ 26 | |
| | Maximum Power Dissipation@ $T_A^{(3)}$ | $T_A=25^\circ\text{C}$ 4.2 | |
| | | $T_A=70^\circ\text{C}$ 2.7 | |



| Symbol | Parameter | Rating | Unit |
|---------------------------------------|--|--------|------|
| $R_{\theta JC}$ | Thermal Resistance-Junction to Case | 2.4 | °C/W |
| $R_{\theta JA}$ ^③ | Thermal Resistance-Junction to Ambient | 62 | °C/W |
| Drain-Source Avalanche Ratings | | | |
| E_{AS} ^④ | Avalanche Energy, Single Pulsed | 121 | mJ |

Electrical Characteristics (T_C=25°C Unless Otherwise Noted)

| Symbol | Parameter | Test Condition | LIMIT | | | Unit |
|---|----------------------------------|---|--|------|-----------|------------|
| | | | Min. | Typ. | Max. | |
| Static Characteristics | | | | | | |
| BV_{DSS} | Drain-Source Breakdown Voltage | $V_{GS}=0V, I_{DS}=250\mu A$ | 40 | | | V |
| I_{DSS} | Zero Gate Voltage Drain Current | $V_{DS}=40V, V_{GS}=0V$ | | | 1 | μA |
| | | $T_J=125^\circ C$ | | | 30 | |
| $V_{GS(th)}$ | Gate Threshold Voltage | $V_{DS}=V_{GS}, I_{DS}=250\mu A$ | 1 | | 2.5 | V |
| I_{GSS} | Gate Leakage Current | $V_{GS}=\pm 20V, V_{DS}=0V$ | | | ± 100 | nA |
| $R_{DS(ON)}$ ^⑤ | Drain-Source On-state Resistance | $V_{GS}=4.5V, I_{DS}=35A$ | | 6.8 | 9.0 | m Ω |
| | | $V_{GS}=10V, I_{DS}=50A$ | | 4.8 | 6.0 | m Ω |
| Diode Characteristics | | | | | | |
| V_{SD} ^⑤ | Diode Forward Voltage | $I_{SD}=50A, V_{GS}=0V$ | | | 1.2 | V |
| t_{rr} | Reverse Recovery Time | $I_{SD}=50A, dI_{SD}/dt=100A/\mu s$ | | 18 | | ns |
| Q_{rr} | Reverse Recovery Charge | | | 9 | | nC |
| Dynamic Characteristics ^⑥ | | | | | | |
| R_G | Gate Resistance | $V_{GS}=0V, V_{DS}=0V, F=1MHz$ | | 1.3 | | Ω |
| C_{iss} | Input Capacitance | $V_{GS}=0V, V_{DS}=20V, Frequency=1.0MHz$ | | 2660 | | pF |
| C_{oss} | Output Capacitance | | | 203 | | |
| C_{riss} | Reverse Transfer Capacitance | | | 177 | | |
| $t_{d(ON)}$ | Turn-on Delay Time | | $V_{DD}=20V, I_{DS}=50A, V_{GEN}=10V, R_G=4.7\Omega$ | | 7.2 | |
| t_r | Turn-on Rise Time | | | 14 | | |
| $t_{d(OFF)}$ | Turn-off Delay Time | | | 19 | | |
| t_f | Turn-off Fall Time | | | 9 | | |
| Gate Charge Characteristics ^⑥ | | | | | | |
| Q_g | Total Gate Charge | $V_{DS}=32V, V_{GS}=10V, I_{DS}=50A$ | | 41 | | nC |
| Q_{gs} | Gate-Source Charge | | | 6.5 | | |
| Q_{gd} | Gate-Drain Charge | | | 7.9 | | |



Typical Characteristics

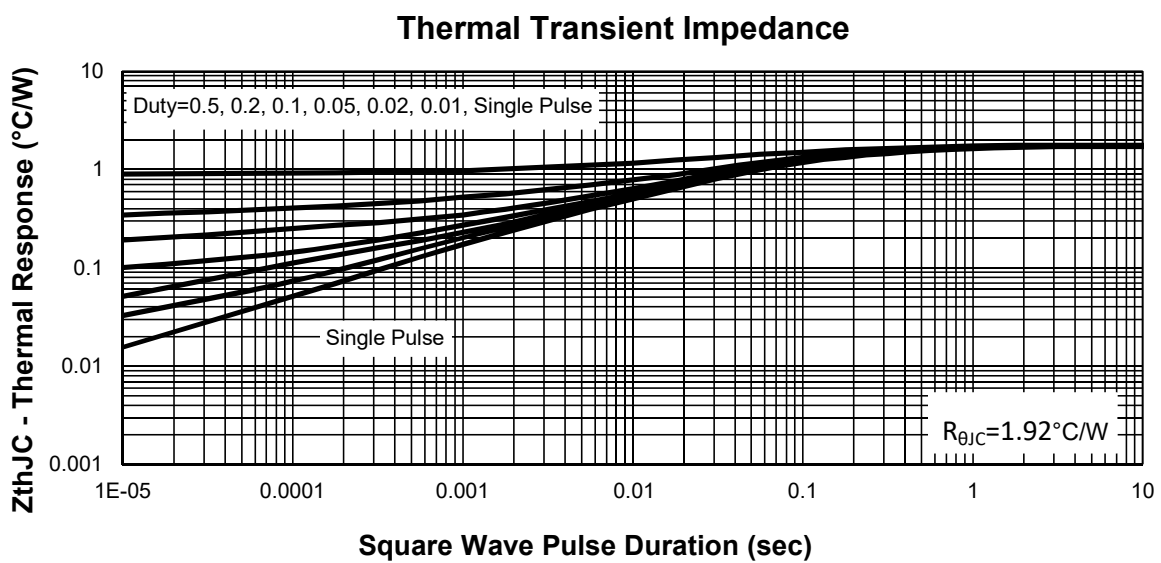
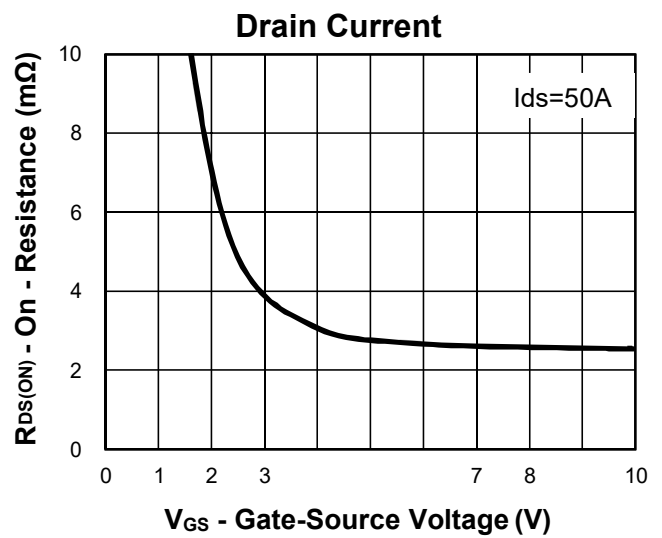
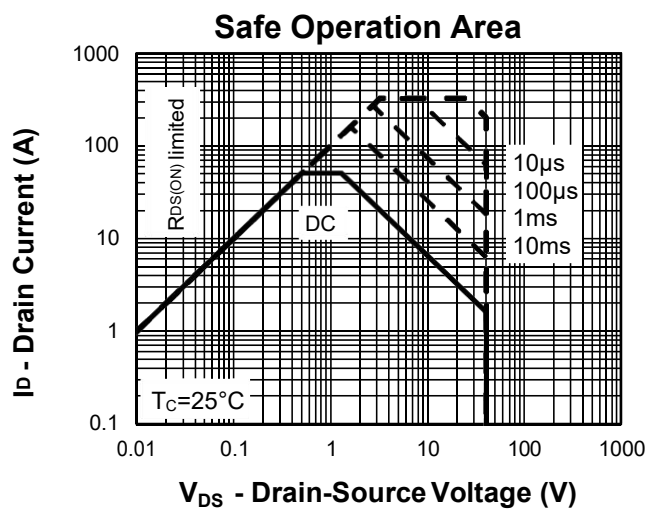
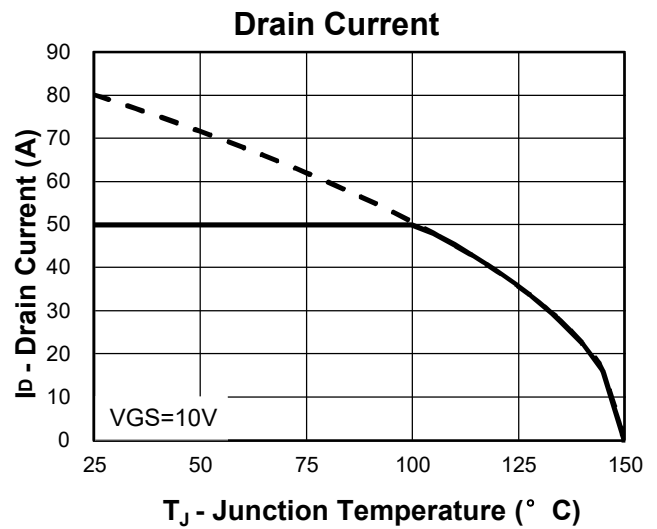
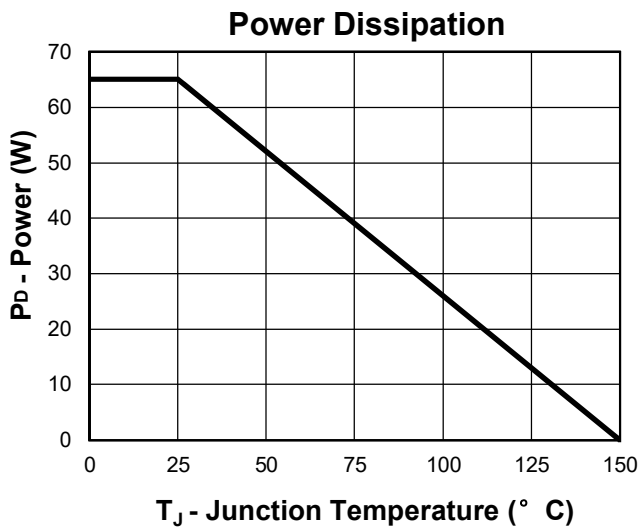



Typical Characteristics

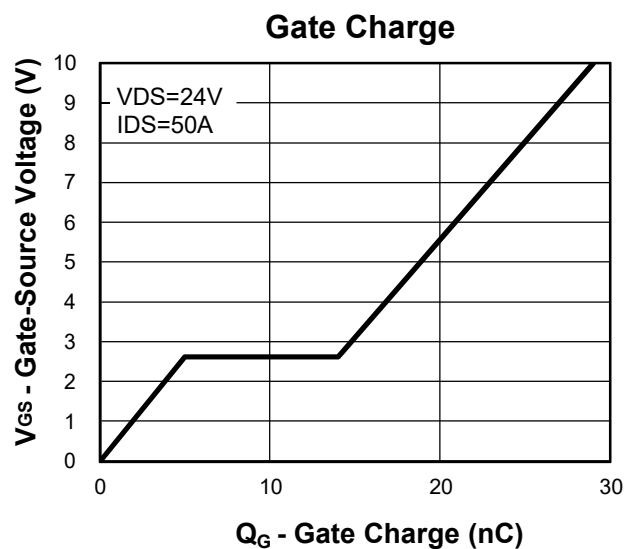
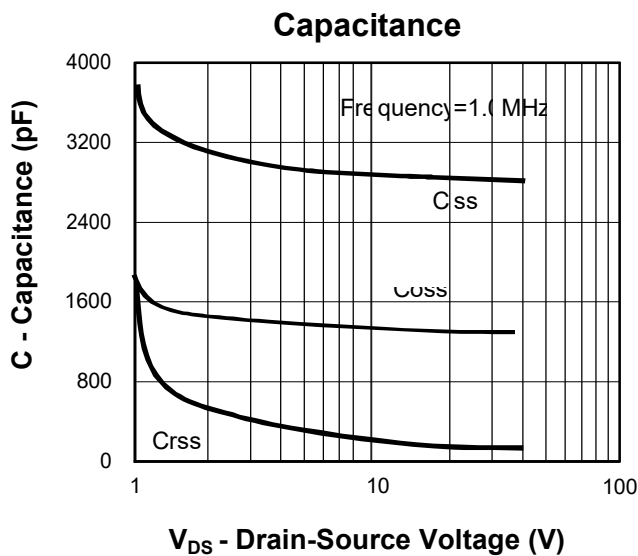
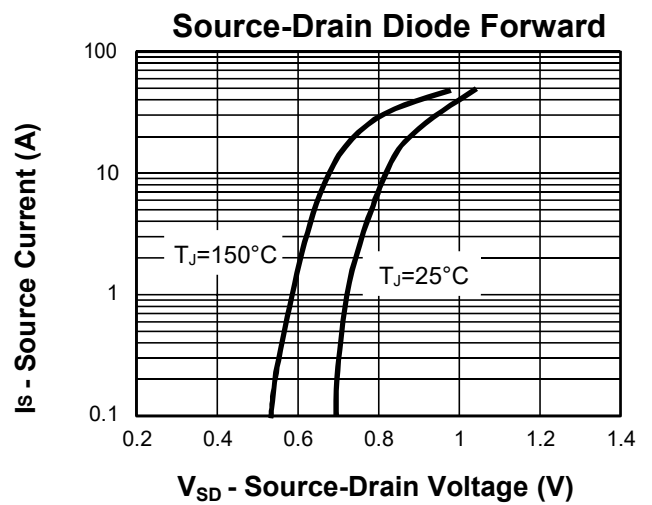
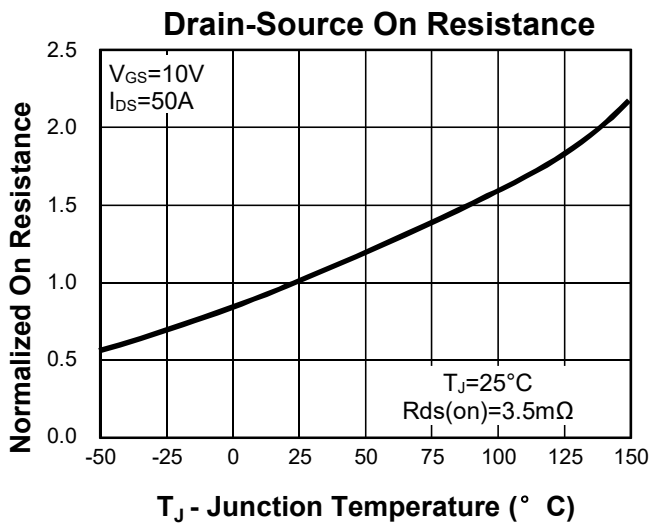
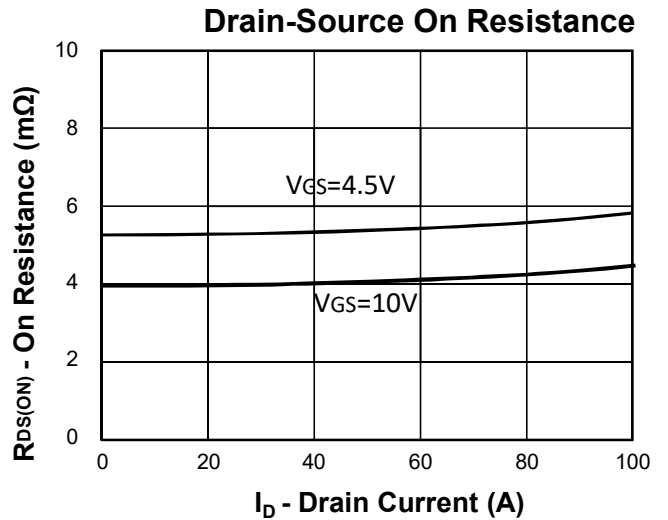
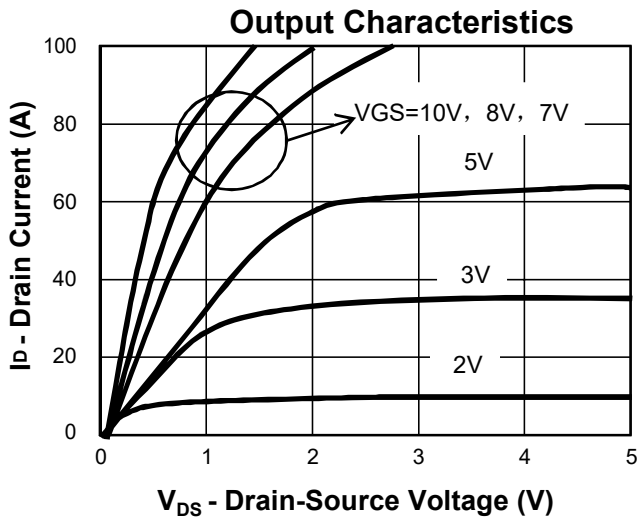



Avalanche Test Circuit and Waveforms

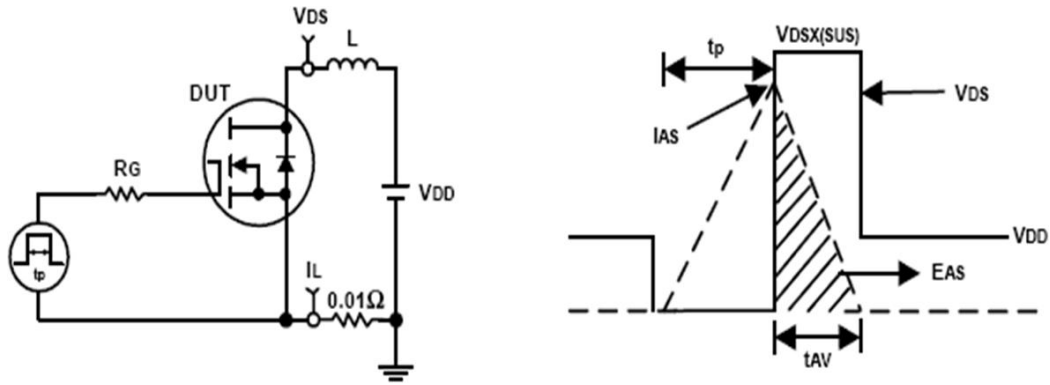

Switching Time Test Circuit and Waveforms

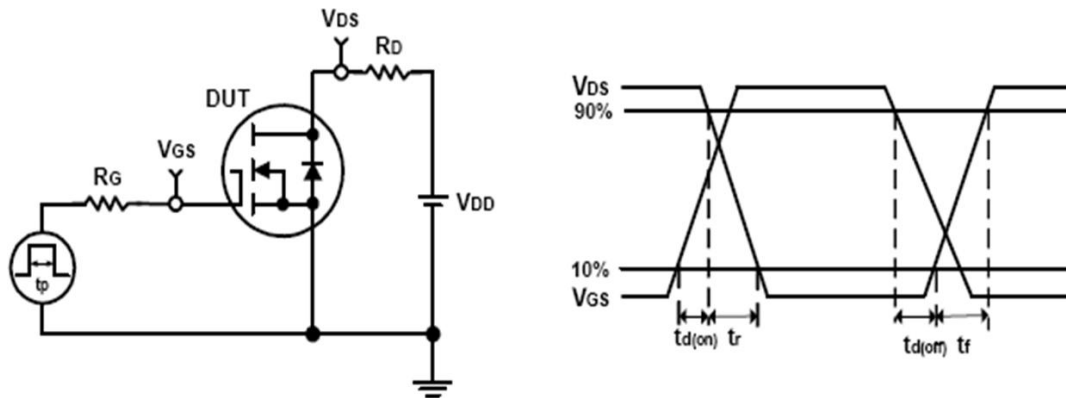



Ordering and Marking Information

| Ordering Device No. | Marking | Package | Packing | Quantity |
|---------------------|---------|----------|-----------|-----------|
| WLQ80N04 | 80N04 | PDFN5060 | Tape&Reel | 5000/Reel |

| PACKAGE | MARKING |
|----------|---------|
| PDFN5060 | 80N04 |



Package Information

PDFN5060

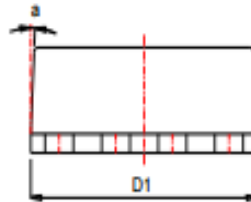
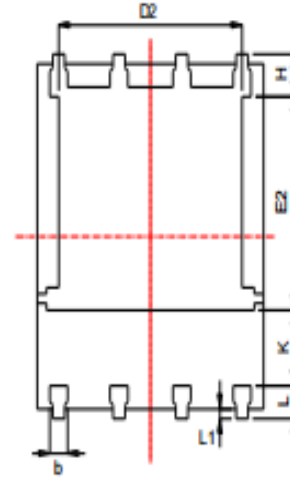
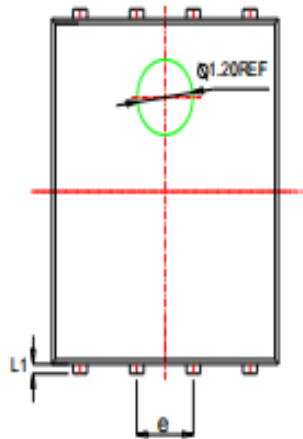

Land Pattern
(Only for Reference)

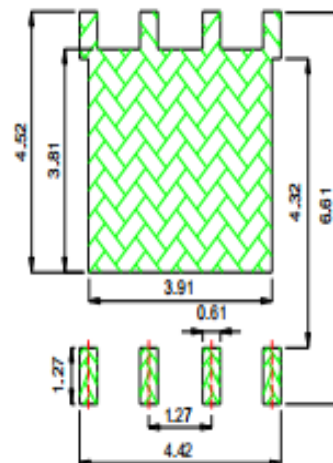

| SYMBOL | MM | | | INCH | | |
|--------|----------|------|------|-----------|-------|-------|
| | MIN | NOM | MAX | MIN | NOM | MAX |
| A | 0.90 | 1.00 | 1.10 | 0.035 | 0.039 | 0.043 |
| b | 0.33 | 0.42 | 0.51 | 0.013 | 0.017 | 0.020 |
| c | 0.20 | 0.25 | 0.30 | 0.008 | 0.010 | 0.012 |
| D1 | 4.80 | 4.90 | 5.00 | 0.189 | 0.193 | 0.197 |
| D2 | 3.61 | 3.79 | 3.96 | 0.142 | 0.149 | 0.156 |
| E | 5.90 | 6.00 | 6.10 | 0.232 | 0.236 | 0.240 |
| E1 | 5.65 | 5.75 | 5.85 | 0.222 | 0.226 | 0.230 |
| E2 | 3.38 | 3.58 | 3.78 | 0.133 | 0.141 | 0.149 |
| e | 1.27 BSC | | | 0.050 BSC | | |
| H | 0.41 | 0.51 | 0.61 | 0.016 | 0.020 | 0.024 |
| k | 1.10 | | | 0.043 | | |
| L | 0.51 | 0.61 | 0.71 | 0.020 | 0.024 | 0.028 |
| L1 | 0.06 | 0.13 | 0.20 | 0.002 | 0.005 | 0.008 |
| a | 0° | | 12° | 0° | | 12° |



Disclaimer

Brunei has made reasonable commercial efforts to ensure that the information given in this datasheet is correct. However, it must clearly be understood that such information is for guidance only and does not constitute any representation or form part of any offer or contract.

For documents and material available from this datasheet, Brunei does not warrant or assume any legal liability or responsibility for the accuracy, completeness, or usefulness of any information, product, technology or process disclosed hereunder.

Brunei reserves the rights to at its own discretion to make any changes or improvements to this datasheet. Unless said datasheet is incorporated into the formal contract, any customer should not rely on the information as any specification or product parameters duly committed by Brunei Customers are hereby advised to verify that the information contained herein is current and complete before the entering of any contract or acknowledgement of any purchase order. Accordingly, all products specified hereunder shall be sold subject to Brunei's terms and conditions supplied at the time of order acknowledgement. Except where agreed upon by contractual agreement, testing of all parameters of each product is not necessarily performed.

Brunei does not warrant or convey any license either expressed or implied under its patent rights, nor the rights of others. Reproduction of information contained herein shall be only permissible if such reproduction is without any modification or alteration. Reproduction of this information with any alteration is an unfair and deceptive business practice. Brunei is not responsible or liable for such altered documentation.

Resale of Brunei's products with statements different from or beyond the parameters stated by Brunei for that product or service voids all express or implied warranties for the associated Brunei's product or service and is unfair and deceptive business practice. Brunei is not responsible or liable for any such statements.

Brunei's products are not authorized for use as critical components in life support devices or systems without the express written approval of Brunei. As used herein:

1. Life support devices or systems are devices or systems which, (a) are intended for surgical implant into the body, or (b) support or sustain life, and whose failure to perform, when properly used in accordance with instructions for use provided in the labeling, can be reasonably expected to result in a significant injury to the user.
2. A critical component is any component of a life support device or system whose failure to perform can be reasonably expected to cause the failure of the life support device or system, or to affect its safety or effectiveness.