



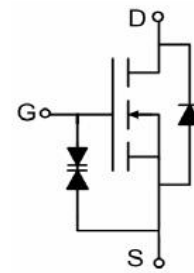
- ★ Green Device Available
- ★ Super Low Gate Charge
- ★ Excellent Cdv/dt effect decline
- ★ Advanced high cell density Trench technology

### Description

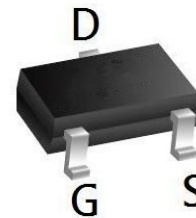
The WL2N7002 is the high cell density trenched N-ch MOSFETs, which provides excellent RDSON and efficiency for most of the small power switching and load switch applications.

The WL2N7002 meet the RoHS and Green Product requirement with full function reliability approved.

ESD Rating: 2000V HBM



### SOT23 Pin Configuration



### Product Summary

BVDSS	RDSON	ID
60V	1.9 Ω	300m A

### Absolute Maximum Ratings (T<sub>A</sub>=25°C unless otherwise specified)

Symbol	Parameter	Max.	Units
V <sub>DSS</sub>	Drain-Source Voltage	60	V
V <sub>GSS</sub>	Gate-Source Voltage	±20	V
I <sub>D</sub>	Continuous Drain Current	T <sub>A</sub> = 25°C	0.3
		T <sub>A</sub> = 100°C	0.2
I <sub>DM</sub>	Pulsed Drain Current <sup>note1</sup>	1.2	A
P <sub>D</sub>	Power Dissipation	0.35	W
R <sub>θJA</sub>	Thermal Resistance, Junction to Ambient	357	°C/W
T <sub>J</sub> , T <sub>STG</sub>	Operating and Storage Temperature Range	-55 to +150	°C

**Electrical Characteristics** ( $T_J=25^{\circ}\text{C}$  unless otherwise specified)

Symbol	Parameter	Test Condition	Min.	Typ.	Max.	Units
<b>Off Characteristic</b>						
$V_{(BR)DSS}$	Drain-Source Breakdown Voltage	$V_{GS}=0V, I_D=250\mu A$	60	-	-	V
$I_{DSS}$	Zero Gate Voltage Drain Current	$V_{DS}=60V, V_{GS}=0V,$	-	-	1	$\mu A$
$I_{GSS}$	Gate to Body Leakage Current	$V_{DS}=0V, V_{GS}=\pm 20V$	-	-	$\pm 10$	$\mu A$
<b>On Characteristics</b>						
$V_{GS(th)}$	Gate Threshold Voltage	$V_{DS}=V_{GS}, I_D=250\mu A$	1	1.5	2.5	V
$R_{DS(on)}$	Static Drain-Source on-Resistance <small>note2</small>	$V_{GS}=10V, I_D=0.3A$	-	1.9	2.2	$\Omega$
		$V_{GS}=4.5V, I_D=0.2A$	-	2.05	2.87	
<b>Dynamic Characteristics</b>						
$C_{iss}$	Input Capacitance	$V_{DS}=25V, V_{GS}=0V,$ $f=1.0MHz$	-	28	-	pF
$C_{oss}$	Output Capacitance		-	11	-	pF
$C_{rss}$	Reverse Transfer Capacitance		-	4	-	pF
$Q_g$	Total Gate Charge	$V_{DS}=10V, I_D=0.3A,$ $V_{GS}=4.5V$	-	1.7	-	nC
$Q_{gs}$	Gate-Source Charge		-	0.3	-	nC
$Q_{gd}$	Gate-Drain("Miller") Charge		-	0.6	-	nC
<b>Switching Characteristics</b>						
$t_{d(on)}$	Turn-on Delay Time	$V_{DD}=10V, I_D=0.2A,$ $R_{GEN}=10\Omega, V_{GS}=10V,$	-	2	-	ns
$t_r$	Turn-on Rise Time		-	15	-	ns
$t_{d(off)}$	Turn-off Delay Time		-	7	-	ns
$t_f$	Turn-off Fall Time		-	20	-	ns
<b>Drain-Source Diode Characteristics and Maximum Ratings</b>						
$I_S$	Maximum Continuous Drain to Source Diode Forward Current		-	-	0.3	A
$I_{SM}$	Maximum Pulsed Drain to Source Diode Forward Current		-	-	1.2	A
$V_{SD}$	Drain to Source Diode Forward Voltage	$V_{GS}=0V, I_S=0.3A$	-	-	1.2	V

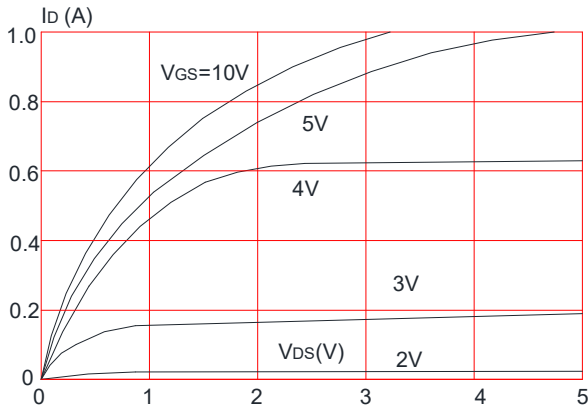
Notes: 1. Repetitive Rating: Pulse Width Limited by Maximum Junction Temperature

2. Pulse Test: Pulse Width $\leq 300\mu s$ , Duty Cycle $\leq 2\%$

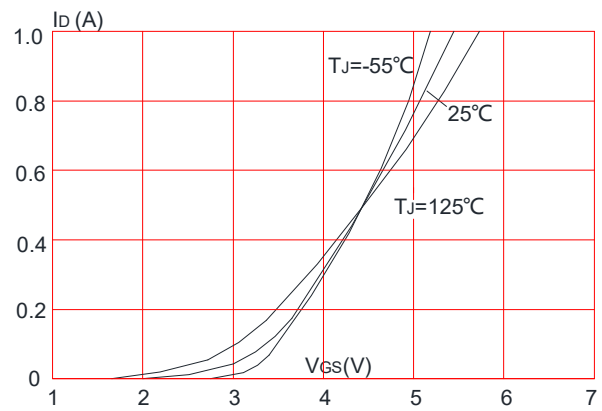


### Typical Performance Characteristics

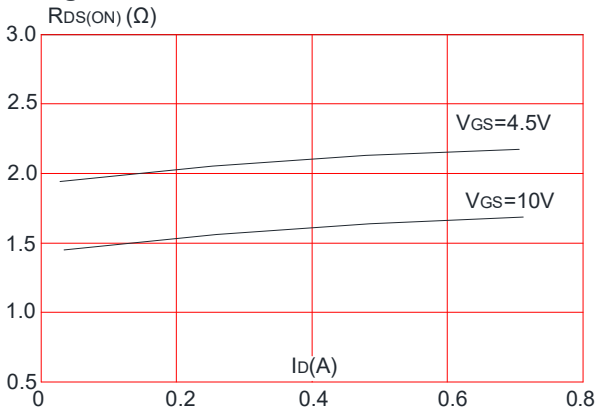
**Figure 1: Output Characteristics**



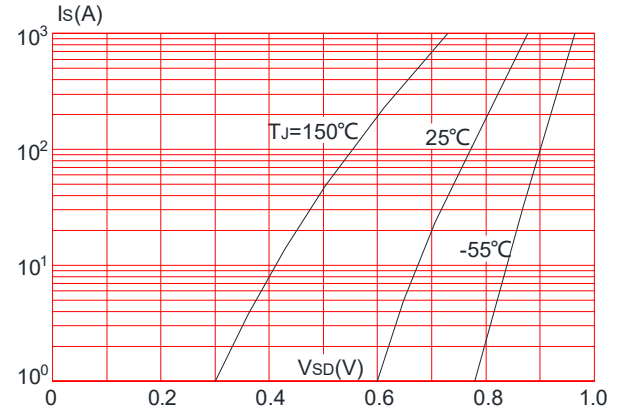
**Figure 2: Typical Transfer Characteristics**



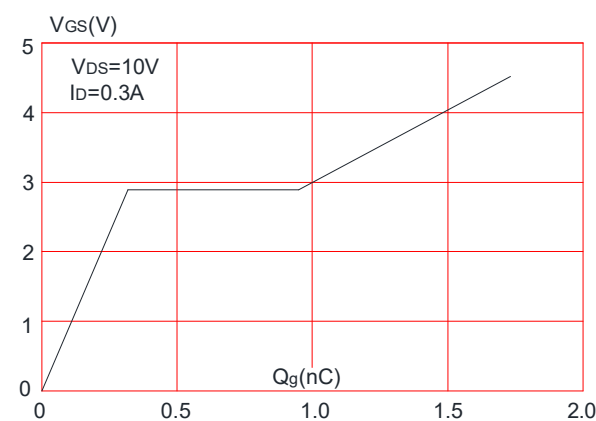
**Figure 3: On-resistance vs. Drain Current**



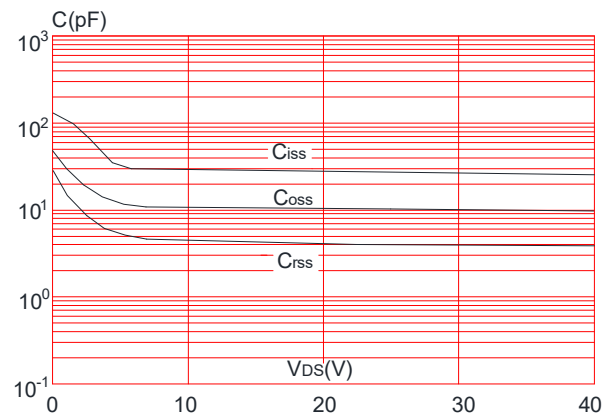
**Figure 4: Body Diode Characteristics**



**Figure 5: Gate Charge Characteristics**

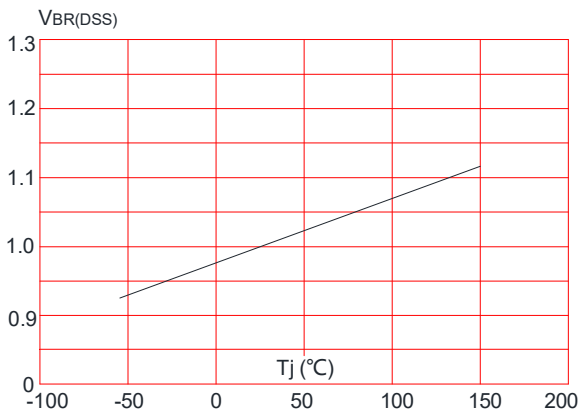


**Figure 6: Capacitance Characteristics**

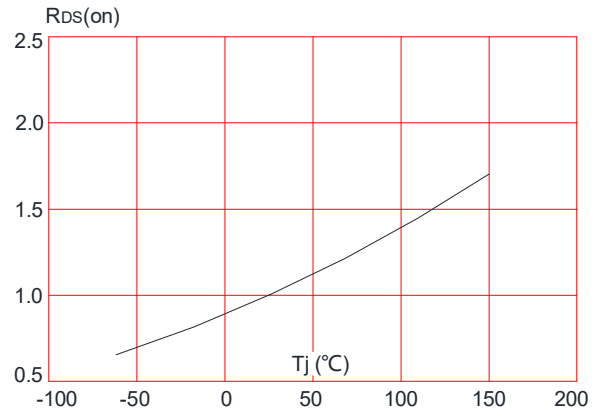




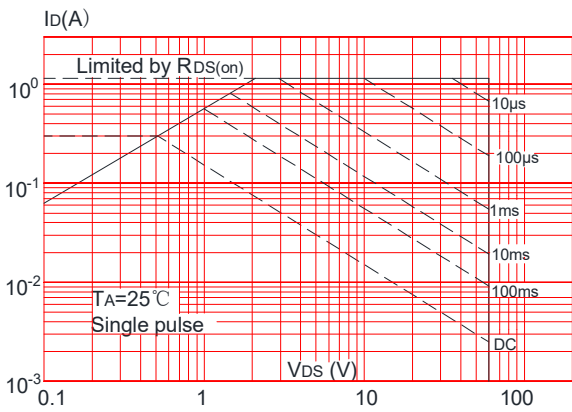
**Figure 7: Normalized Breakdown Voltage vs. Junction Temperature**



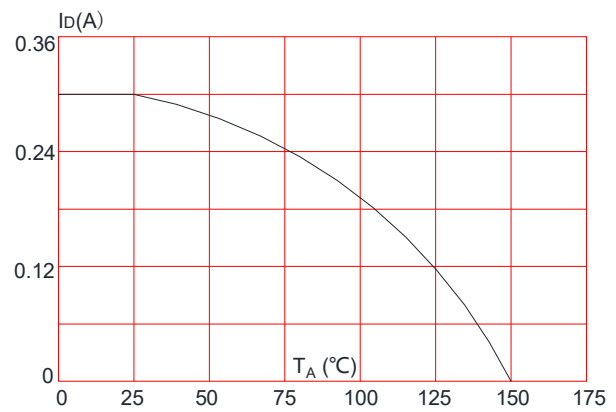
**Figure 8: Normalized on Resistance vs. Junction Temperature**



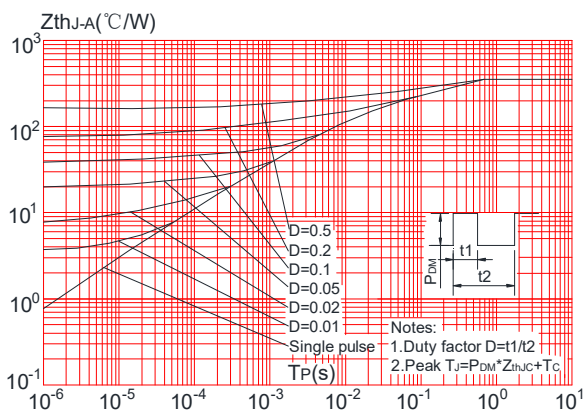
**Figure 9: Maximum Safe Operating Area**



**Figure 10: Maximum Continuous Drain Current vs. Ambient Temperature**

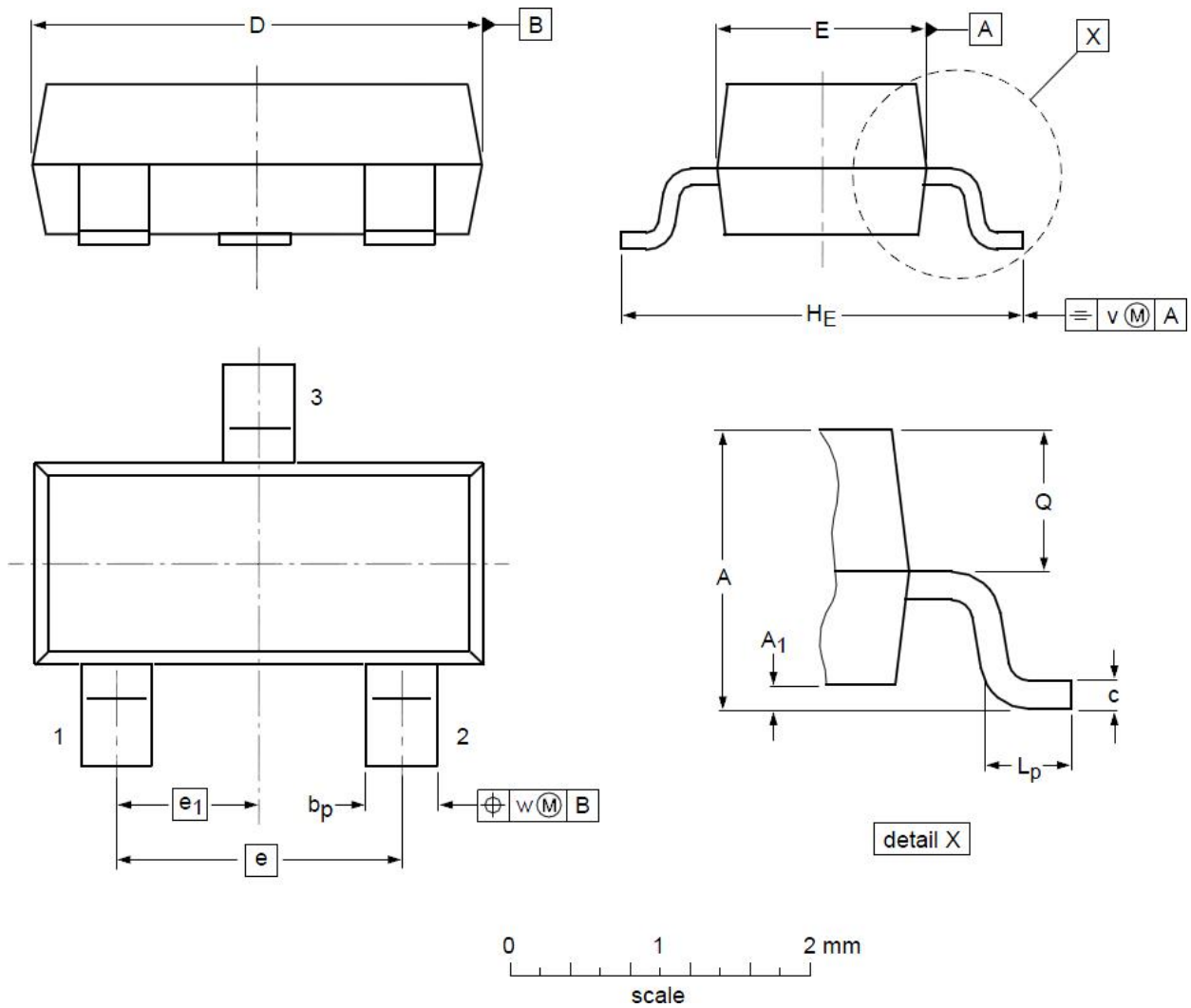


**Figure 11: Maximum Effective Transient Thermal Impedance, Junction-to-Ambient**





SOT23 Mechanical Data



DIMENSIONS ( unit : mm )

Symbol	Min	Typ	Max	Symbol	Min	Typ	Max
A	0.90	1.01	1.15	A <sub>1</sub>	0.01	0.05	0.10
b <sub>p</sub>	0.30	0.42	0.50	c	0.08	0.13	0.15
D	2.80	2.92	3.00	E	1.20	1.33	1.40
e	--	1.90	--	e <sub>1</sub>	--	0.95	--
H <sub>E</sub>	2.25	2.40	2.55	L <sub>p</sub>	0.30	0.42	0.50
Q	0.45	0.49	0.55	v	--	0.20	--
w	--	0.10	--				



## **Disclaimer**

Brunei has made reasonable commercial efforts to ensure that the information given in this datasheet is correct. However, it must clearly be understood that such information is for guidance only and does not constitute any representation or form part of any offer or contract.

For documents and material available from this datasheet, Brunei does not warrant or assume any legal liability or responsibility for the accuracy, completeness, or usefulness of any information, product, technology or process disclosed hereunder.

Brunei reserves the rights to at its own discretion to make any changes or improvements to this datasheet. Unless said datasheet is incorporated into the formal contract, any customer should not rely on the information as any specification or product parameters duly committed by Brunei Customers are hereby advised to verify that the information contained herein is current and complete before the entering of any contract or acknowledgement of any purchase order. Accordingly, all products specified hereunder shall be sold subject to Brunei's terms and conditions supplied at the time of order acknowledgement. Except where agreed upon by contractual agreement, testing of all parameters of each product is not necessarily performed.

Brunei does not warrant or convey any license either expressed or implied under its patent rights, nor the rights of others. Reproduction of information contained herein shall be only permissible if such reproduction is without any modification or alteration. Reproduction of this information with any alteration is an unfair and deceptive business practice. Brunei is not responsible or liable for such altered documentation.

Resale of Brunei's products with statements different from or beyond the parameters stated by Brunei for that product or service voids all express or implied warranties for the associated Brunei's product or service and is unfair and deceptive business practice. Brunei is not responsible or liable for any such statements.

Brunei's products are not authorized for use as critical components in life support devices or systems without the express written approval of Brunei. As used herein:

1. Life support devices or systems are devices or systems which, (a) are intended for surgical implant into the body, or (b) support or sustain life, and whose failure to perform, when properly used in accordance with instructions for use provided in the labeling, can be reasonably expected to result in a significant injury to the user.
2. A critical component is any component of a life support device or system whose failure to perform can be reasonably expected to cause the failure of the life support device or system, or to affect its safety or effectiveness.