

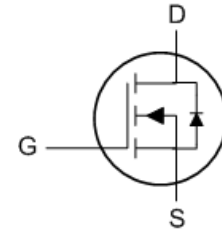

Features

- ★ Advanced Trench MOS Technology
- ★ 100% EAS Guaranteed
- ★ Fast Switching Speed
- ★ Green Device Available



Applications

- ★ High Frequency Switching and Synchronous Rectification.
- ★ DC/DC Converter.

PDFN 3X3 Pin Configuration

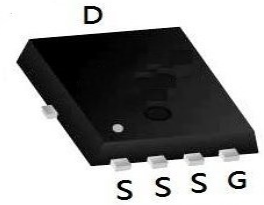

Features

- 40V/60A,
 $R_{DS(ON)} = 5\text{m}\Omega(\text{Typ.})@V_{GS}=10\text{V}$
 $R_{DS(ON)} = 6.5\text{m}\Omega(\text{Typ.})@V_{GS}=4.5\text{V}$

Absolute Maximum Ratings

Symbol	Parameter	Rating	Units
V_{DS}	Drain-Source Voltage	40	V
V_{GS}	Gate-Source Voltage	± 20	V
$I_D@T_C=25^\circ\text{C}$	Continuous Drain Current ¹	60	A
$I_D@T_C=100^\circ\text{C}$	Continuous Drain Current ¹	35	A
I_{DM}	Pulsed Drain Current ²	130	A
EAS	Single Pulse Avalanche Energy ³	48	mJ
I_{AS}	Avalanche Current	35	A
$P_D@T_C=25^\circ\text{C}$	Total Power Dissipation ⁴	39	W
T_{STG}	Storage Temperature Range	-55 to 150	$^\circ\text{C}$
T_J	Operating Junction Temperature Range	-55 to 150	$^\circ\text{C}$

Thermal Data

Symbol	Parameter	Typ.	Max.	Unit
$R_{\theta JA}$	Thermal Resistance Junction-ambient (Steady State) ¹	---	60	$^\circ\text{C}/\text{W}$
$R_{\theta JC}$	Thermal Resistance Junction-Case ¹	---	3.2	$^\circ\text{C}/\text{W}$



Electrical Characteristics ($T_J=25\text{ }^\circ\text{C}$, unless otherwise noted)

Symbol	Parameter	Conditions	Min.	Typ.	Max.	Unit
BV_{DSS}	Drain-Source Breakdown Voltage	$V_{GS}=0V, I_D=250\mu A$	40	---	---	V
$R_{DS(ON)}$	Static Drain-Source On-Resistance ²	$V_{GS}=10V, I_D=12A$	---	5	6.5	m Ω
		$V_{GS}=4.5V, I_D=10A$	---	6.5	9	
$V_{GS(th)}$	Gate Threshold Voltage	$V_{GS}=V_{DS}, I_D=250\mu A$	1.35	---	3	V
I_{DSS}	Drain-Source Leakage Current	$V_{DS}=32V, V_{GS}=0V, T_J=25^\circ\text{C}$	---	---	1	μA
		$V_{DS}=32V, V_{GS}=0V, T_J=55^\circ\text{C}$	---	---	5	
I_{GSS}	Gate-Source Leakage Current	$V_{GS}=\pm 20V, V_{DS}=0V$	---	---	± 100	nA
R_g	Gate Resistance	$V_{DS}=0V, V_{GS}=0V, f=1\text{MHz}$	---	1.7	---	Ω
Q_g	Total Gate Charge (4.5V)	$V_{DS}=20V, V_{GS}=4.5V, I_D=12A$	---	5.8	---	nC
Q_{gs}	Gate-Source Charge		---	3	---	
Q_{gd}	Gate-Drain Charge		---	1.2	---	
$T_{d(on)}$	Turn-On Delay Time	$V_{DD}=15V, V_{GS}=10V, R_G=3.3\Omega$ $I_D=1A$	---	14.3	---	ns
T_r	Rise Time		---	5.6	---	
$T_{d(off)}$	Turn-Off Delay Time		---	20	---	
T_f	Fall Time		---	11	---	
C_{iss}	Input Capacitance	$V_{DS}=15V, V_{GS}=0V, f=1\text{MHz}$	---	690	---	pF
C_{oss}	Output Capacitance		---	193	---	
C_{riss}	Reverse Transfer Capacitance		---	38	---	

Diode Characteristics

Symbol	Parameter	Conditions	Min.	Typ.	Max.	Unit
I_S	Continuous Source Current ^{1,5}	$V_G=V_D=0V$, Force Current	---	---	60	A
V_{SD}	Diode Forward Voltage ²	$V_{GS}=0V, I_S=1A, T_J=25^\circ\text{C}$	---	---	1	V

Note :

- 1.The data tested by surface mounted on a 1 inch²FR-4 board with 2OZ copper.
- 2.The data tested by pulsed , pulse width $\leq 300\mu s$, duty cycle $\leq 2\%$
- 3.The EAS data shows Max. rating . The test condition is $V_{DD}=25V, V_{GS}=10V, L=0.1mH, I_{AS}=31A$
- 4.The power dissipation is limited by 150 $^\circ\text{C}$ junction temperature
- 5.The data is theoretically the same as I_D and I_{DM} , in real applications , should be limited by total power dissipation.



Typical Characteristics

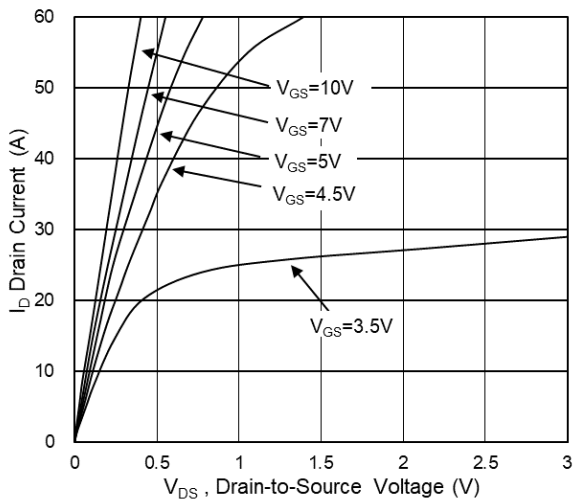

Fig.1 Typical Output Characteristics

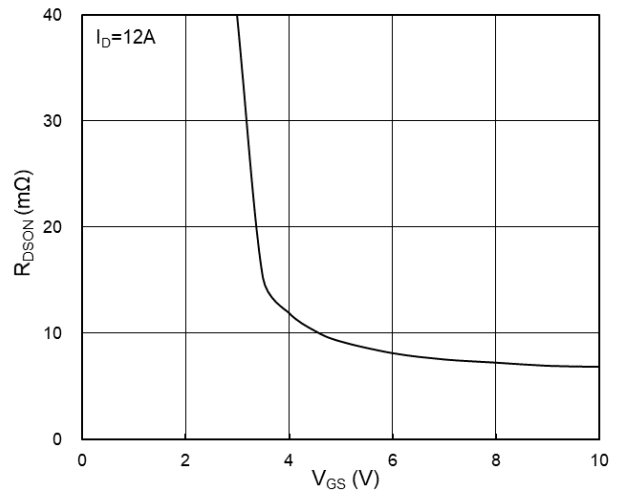

Fig.2 On-Resistance vs G-S Voltage

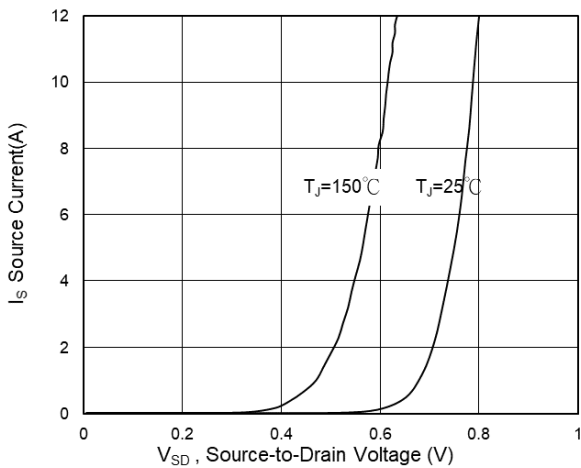

Fig.3 Source Drain Forward Characteristics

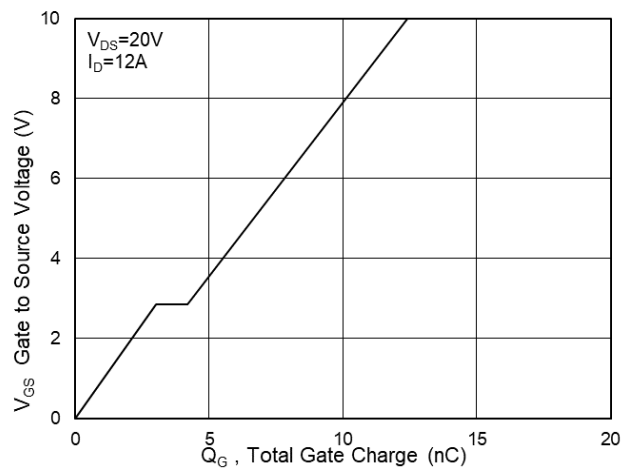

Fig.4 Gate-Charge Characteristics

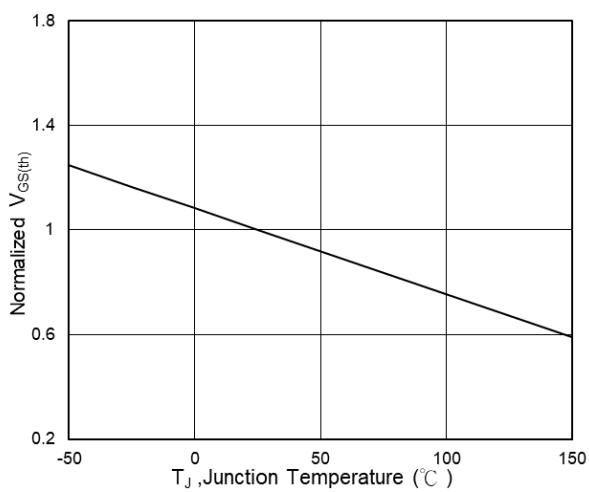

Fig.5 Normalized $V_{GS(th)}$ vs T_J

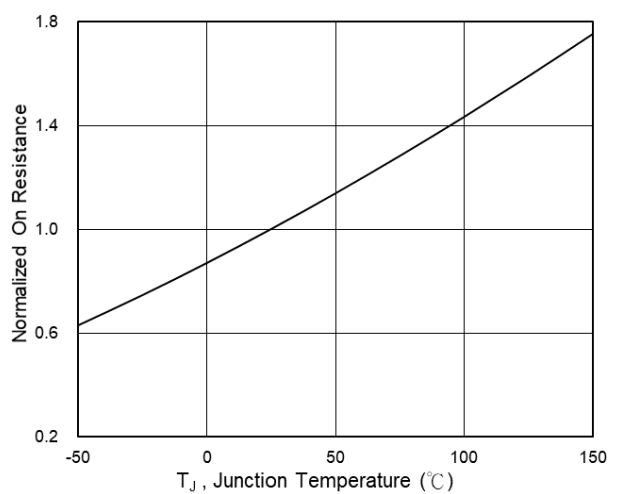

Fig.6 Normalized $R_{DS(on)}$ vs T_J

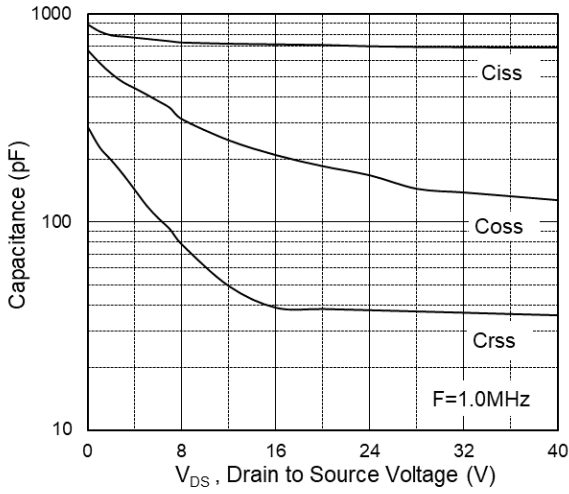

Fig.7 Capacitance

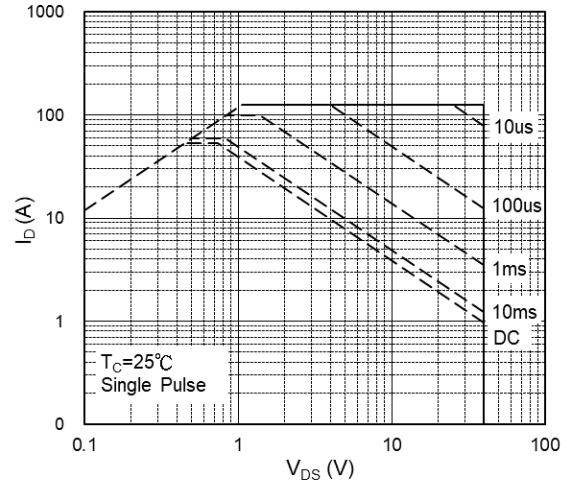

Fig.8 Safe Operating Area

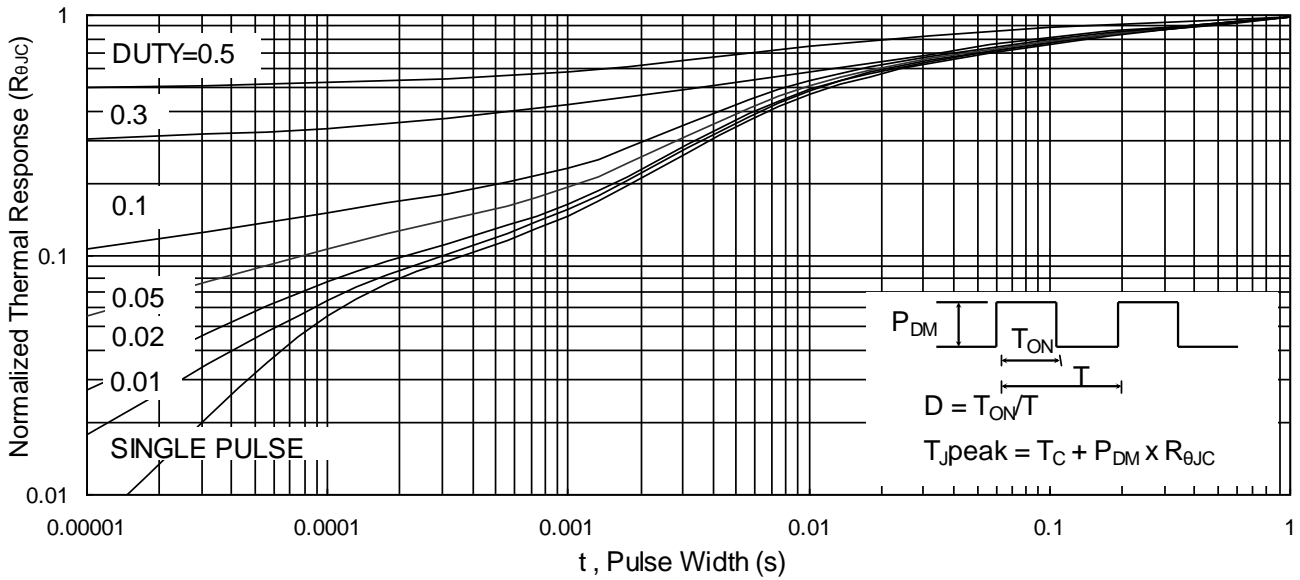

Fig.9 Normalized Maximum Transient Thermal Impedance

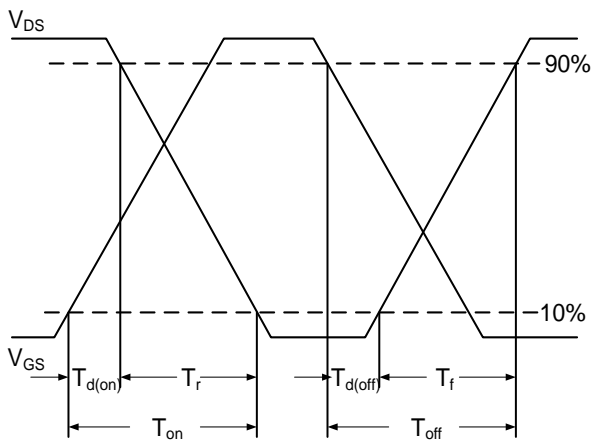

Fig.10 Switching Time Waveform

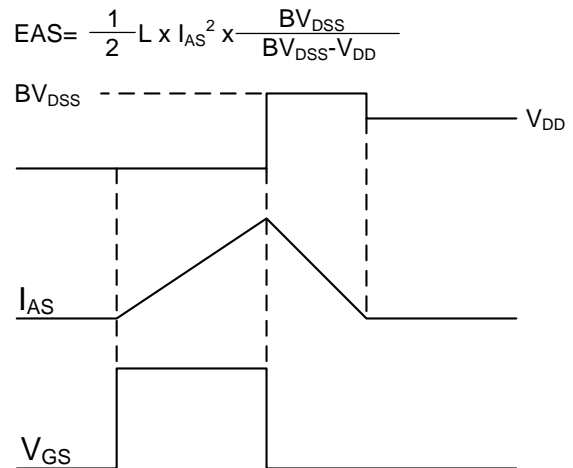
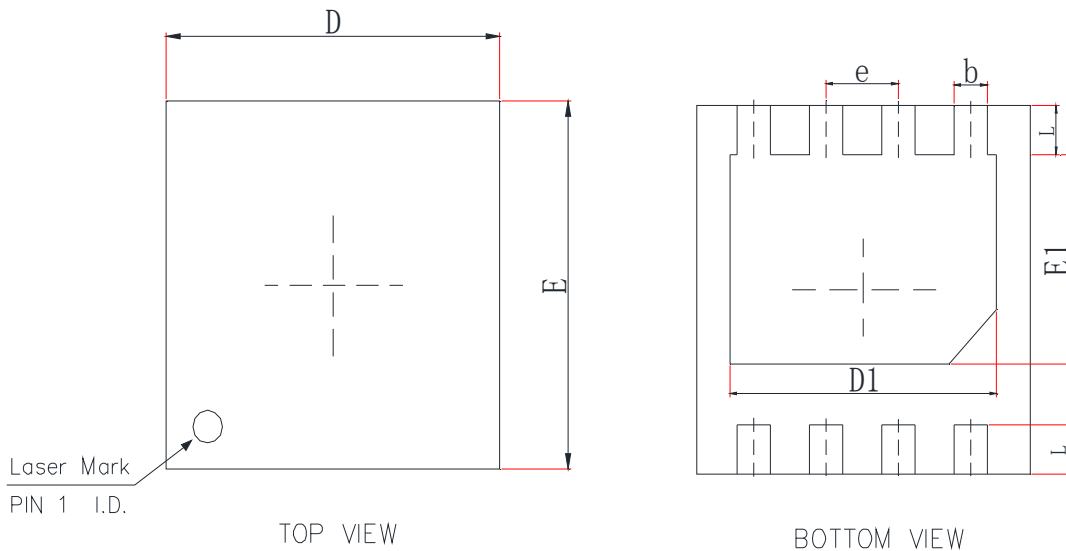

Fig.11 Unclamped Inductive Waveform



Package Information

DFN3030



SYMBOL	MM			INCH		
	MIN	NOM	MAX	MIN	NOM	MAX
A	0.70	0.75	0.80	0.028	0.030	0.031
A1			0.05			0.002
b	0.25	0.30	0.35	0.010	0.012	0.014
c	0.18	0.20	0.30	0.007	0.008	0.012
D	2.95	3.00	3.15	0.116	0.118	0.124
E	2.95	3.00	3.15	0.116	0.118	0.124
D1	2.30	2.40	2.50	0.091	0.094	0.098
E1	1.70	1.80	1.90	0.067	0.071	0.075
L	0.30	0.40	0.50	0.012	0.016	0.020
e	0.65 BSC			0.026 BSC		



Disclaimer

Brunei has made reasonable commercial efforts to ensure that the information given in this datasheet is correct. However, it must clearly be understood that such information is for guidance only and does not constitute any representation or form part of any offer or contract.

For documents and material available from this datasheet, Brunei does not warrant or assume any legal liability or responsibility for the accuracy, completeness, or usefulness of any information, product, technology or process disclosed hereunder.

Brunei reserves the rights to at its own discretion to make any changes or improvements to this datasheet. Unless said datasheet is incorporated into the formal contract, any customer should not rely on the information as any specification or product parameters duly committed by Brunei Customers are hereby advised to verify that the information contained herein is current and complete before the entering of any contract or acknowledgement of any purchase order. Accordingly, all products specified hereunder shall be sold subject to Brunei's terms and conditions supplied at the time of order acknowledgement. Except where agreed upon by contractual agreement, testing of all parameters of each product is not necessarily performed.

Brunei does not warrant or convey any license either expressed or implied under its patent rights, nor the rights of others. Reproduction of information contained herein shall be only permissible if such reproduction is without any modification or alteration. Reproduction of this information with any alteration is an unfair and deceptive business practice. Brunei is not responsible or liable for such altered documentation.

Resale of Brunei's products with statements different from or beyond the parameters stated by Brunei for that product or service voids all express or implied warranties for the associated Brunei's product or service and is unfair and deceptive business practice. Brunei is not responsible or liable for any such statements.

Brunei's products are not authorized for use as critical components in life support devices or systems without the express written approval of Brunei. As used herein:

1. Life support devices or systems are devices or systems which, (a) are intended for surgical implant into the body, or (b) support or sustain life, and whose failure to perform, when properly used in accordance with instructions for use provided in the labeling, can be reasonably expected to result in a significant injury to the user.
2. A critical component is any component of a life support device or system whose failure to perform can be reasonably expected to cause the failure of the life support device or system, or to affect its safety or effectiveness.